

USR-G781 User Manual

File Version: V1.0.06.02



Contents

USR-G781 User Manual	1
Brief Introduction	4
Features	4
1. Get Start	5
1.1. Application	5
1.1.1. Application Diagram	5
1.1.2. Hardware Dimensions	6
1.1.3. Hardware Interface	7
1.1.4. LED Indicator	8
1.2. Module Default Parameters	8
1.3. Basic Parameters	9
1.4. Frequency Band	10
1.5. Hardware Introductions	10
2. Product Functions	12
2.1. APN	12
2.2. Router Functions	13
2.2.1. Configuration procedure	13
2.2.2. Networking mode	14
2.2.2.1. WAN+LAN+4G	14
2.2.2.2. LAN+LAN+4G	14
2.2.3. Features	15
2.2.3.1. 4G Interface	15
2.2.3.2. LAN Interface	15
2.2.3.3. WAN Interface	16
2.2.3.4. DHCP Server function	16
2.2.3.5. VPN function	17
2.2.3.6. Static Routes function	17
2.2.3.7. Static IP binding	18
2.2.3.8. Network diagnosis	18
2.2.3.9. Firewall	19
2.3. DTU Functions	21
2.3.1. Work Mode	21
2.3.1.1. Transparent Mode	21
2.3.1.2. HTTPD Client Mode	23
2.3.2. Serial Port	24
2.3.2.1. Parameters range	24
2.3.2.2. Serial Package Methods	24
2.3.2.3. Baud Rate Synchronization	24
2.3.3. Features	25
2.3.3.1. Identity packet Function	25
2.3.3.2. Heartbeat packet Function	26
2.4. Basic functions	26

2.4.1. Reload by Hardware	26
3. Parameter Setting	27
3.1. Web Server Configuration	27
3.2. AT Command	28
3.2.1. Serial AT Command	28
3.2.2. Setup software	28
3.2.3. Transparent AT Command	28
4. Contact Us	29
5. Disclaimer	29
6. Update History	29

Brief Introduction

USR-G781 is a 3G&4G DTU which apply to LTE WCDMA and GPRS. Serial RS232 or RS485 can be transfer to Internet server via LTE technology. G781 has two Ethernet port for networking accessory.

Features

- ARM 9 core and Linux system based.
- Supports 2G 3G and 4G LTE. Different version for America, Europe, Australia and other areas.
- Support 2 Ethernet RJ45 port. One LAN port, and another one can be set as WAN port or LAN port.
- Support 1 SIM card socket.
- Support PPTP VPN. LT2P, IPSEC and Open VPN are on developing.
- Support DDNS, static routing and firewall.
- Support NTP and clock synchronization.
- Support Web Server configuration.
- Supports 4 connections online simultaneously, supports TCP and UDP
- Supports sending network identity packet.
- Supports sending heartbeat packet data to network or serial port
- Supports 2 serial work modes: Network transparent transmission mode and HTTPD mode
- Dual watchdog timer for stability.

1. Get Start

Product link:

<http://www.usriot.com/p/g781/>

Setup software:

<http://www.usriot.com/usr-g781-setup-software-v1-0-0-0/>

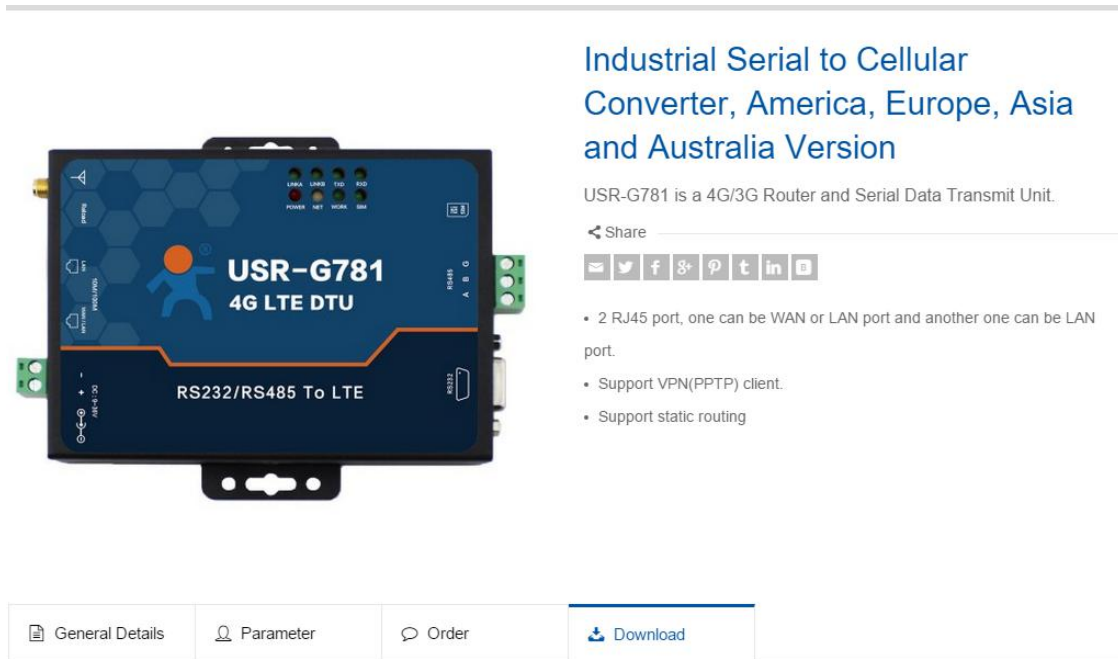

Figure 1 Download Page

If you have any question, please submit it back to customer center: <http://h.usriot.com>

1.1. Application

1.1.1. Application Diagram

When you start using module, the first step is to configure APN settings.

[2.1.APN](#) is chapter for APN settings.

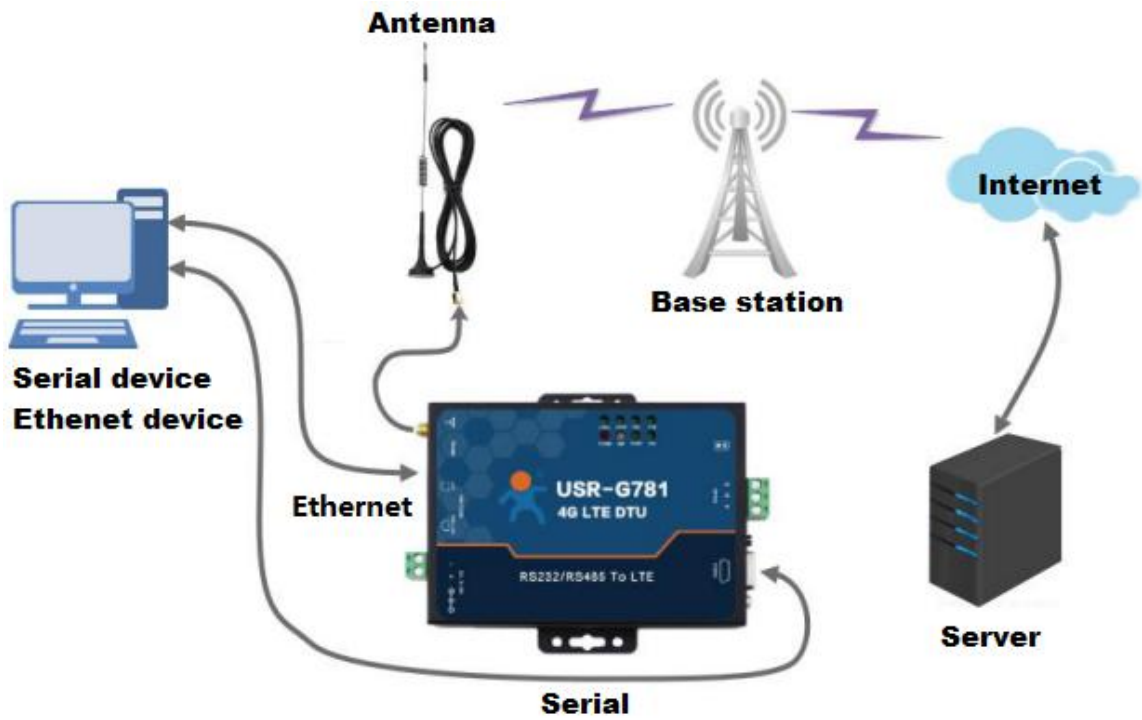

Figure 2 Application diagram

1.1.2. Hardware Dimensions

units: mm

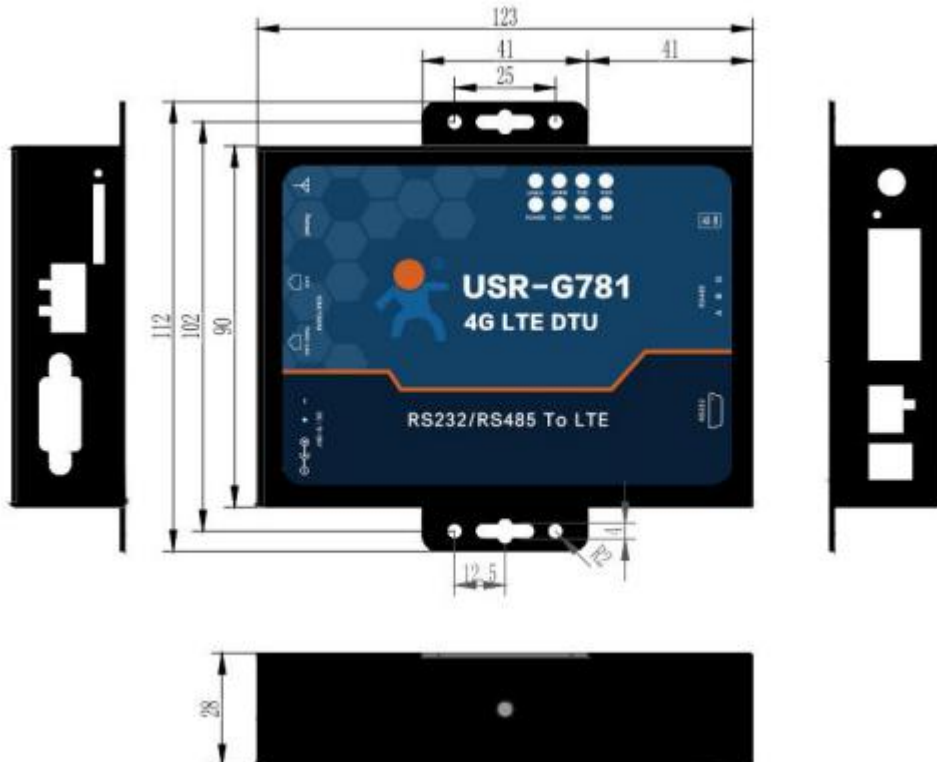

Figure 3 Hardware dimensions

1.1.3. Hardware Interface



Figure 4 Hardware interface



Figure 5 Hardware interface

Interface	Information
LTE antenna	Stick antenna and sucker antenna for chosen
Reload button	Press button for 3~15s to reload to factory settings
Ethernet port	WAN/LAN port can be switch by serial command
Power supply	DC 9~36V power supply
RS232 DB9 female	5 wires RS232(TXD/RXD/GND/RTS/CTS)
RS485 terminal	3 wires RS485: A+/B-/GND
SIM card socket	Insert SIM card here

Figure 6 Interface information

1.1.4. LED Indicator

Indicator	Status
Power	On: Power on
	Off: Power off
NET	Red: 2G network
	Blue: 3G network
	Purple: 4G network
	Off: No network
WORK	On: Working
	Off: Not working
SIM	On: SIM card detected
	Off: SIM card not detected
LINKA	On: Socket A connected
	Off: Socket A disconnected
LINKB	On: Socket B connected
	Off: Socket B disconnected
TXD	On: Sending data to serial
	Off: No data sending to serial
RXD	On: Receiving data from serial
	Off: No data receiving from serial

Figure 7 Hardware Indicator

1.2. Module Default Parameters

Work mode	Transparent mode
Server Address	test.usr.cn
Server Port	2317
Serial Parameters	115200,8,1,None
Heartbeat packet	www.usr.cn

Figure 8 Default parameters

1.3. Basic Parameters

	Parameter	Index
SIM card and antenna	SIM/USIM card	Six pin SIM card interface, 3V/1.8V SIM card
	Antenna	SMA interface, 5dBi antenna
Hardware Parameters	Wired Internet interface	WAN*1 and LAN*1
	Data Interface	RS232:300bps - 460800bps RS485:300bps - 460800bps
	Indicator LED	LINKA, LINKB, TXD, RXD, POWER, NET, WORK, SIM
	Working Voltage	DC 9V~36V
	Working Current	Average current 180mA@12V Peak Current 300mA@12V
	Working Temp.	-25℃ - 85℃
	Storage Temp.	-40℃ - 125℃
	Working humidity	10%~90%
	Storage humidity	5%~90%
	Software Parameters	Work Mode
Setting Command		AT+ Command Structure
Network protocol		TCP/UDP/DNS/HTTP/FTP
Max TCP connections		4
User Configuration Method		Setting Software, AT command and Web Server configuration
Software Functions	VPN	Support PPTP
	Static routing management	Support
	Firewall	Support
	Network diagnosis	Support
	Remote Management	Support
	Transparent Transmission	Support TCP Server/TCP Client/UDP Server/UDP Client
	HTTP Protocol Transmission	Support
	Heartbeat Packet	Support
	Identity Packet	Support IMEI/ICCID/self-defined identity packet
	Baud Rate Synchronization	Support
	USR Cloud	Support

Figure 9 Basic parameters

1.4. Frequency Band

	G781	G781-43	G781-E	G781-V	G781-A	G781-AU
	Operating Band	Operating Band	Operating Band	Operating Band	Operating Band	Operating Band
FDD-LTE	1	1	1			1
					2	2
	3	3	3			3
				4	4	4
			5			5
			7			7
		8	8			8
					12	
				13		
				20		
						28
TDD-LTE	38	38	38			
	39	39				
	40	40	40			40
	41	41	41			
WCDMA	1	1	1			1
					2	2
					4	
			5		5	5
	8	8	8			8
CDMA1X		800MHz				
CDMA2000-EVDO						
GPRS						2
	3	3	3			3
	8	8	8			5
						8

Figure 10 Frequency Band

1.5. Hardware Introductions

Below is the hardware interface schematic diagram of USR-G781



Figure 11 Hardware interface schematic diagram

2. Product Functions

2.1. APN

Different operator have different APN(access point name), if you use the SIM card from the operator. You must know the APN. You can ask your SIM card operator for APN.

There are four parameters about APN. Those are APN Name, User Name, Password and Encrypt. Sometimes only configure APN Name is enough. User can configure the APN settings by Web Server or Setup software as follows:

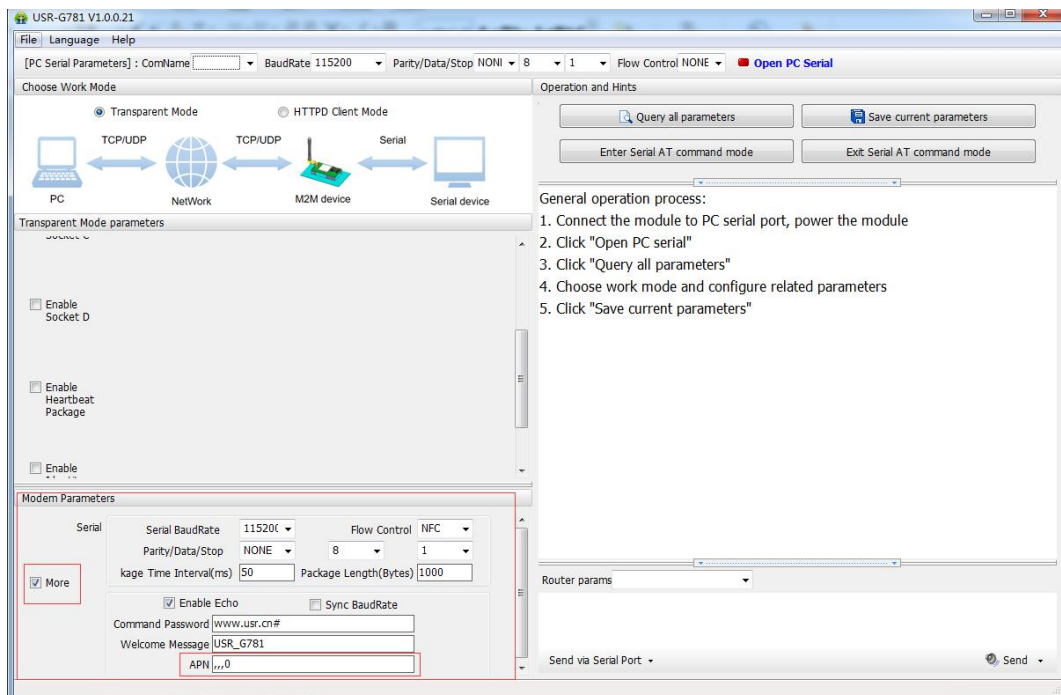
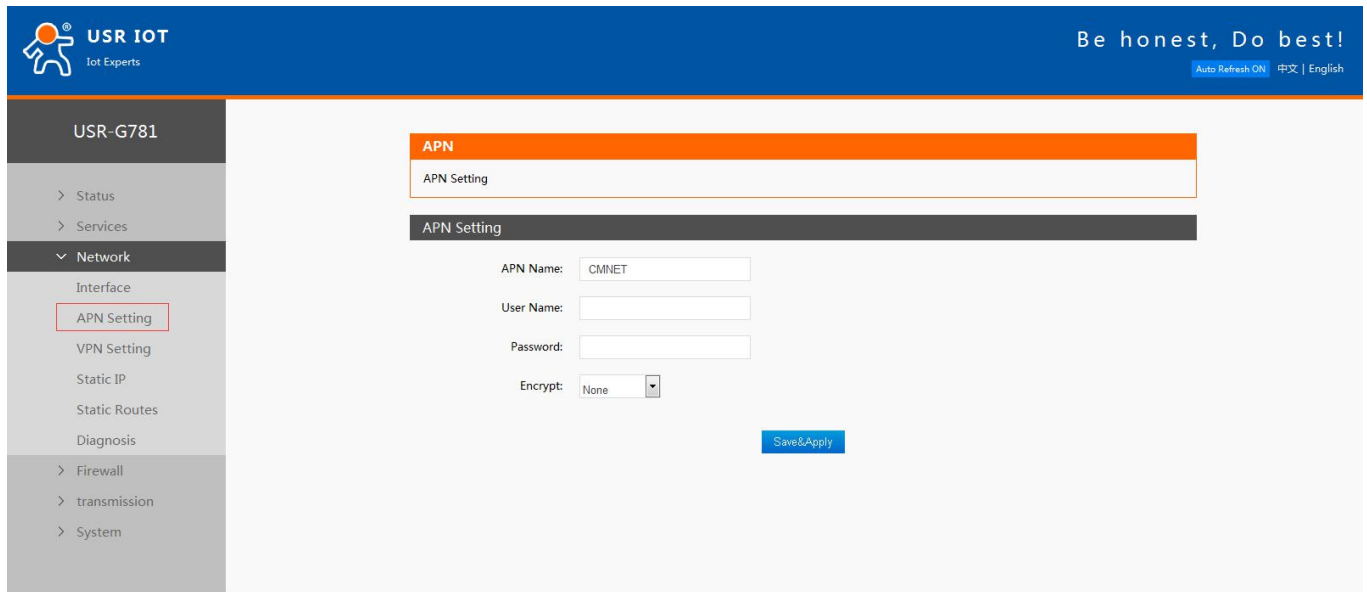

Figure 12 APN configuration

2.2. Router Functions

This chapter introduces the Router functions of USR-G781, as the following diagram shown, you can get an overall knowledge of it.

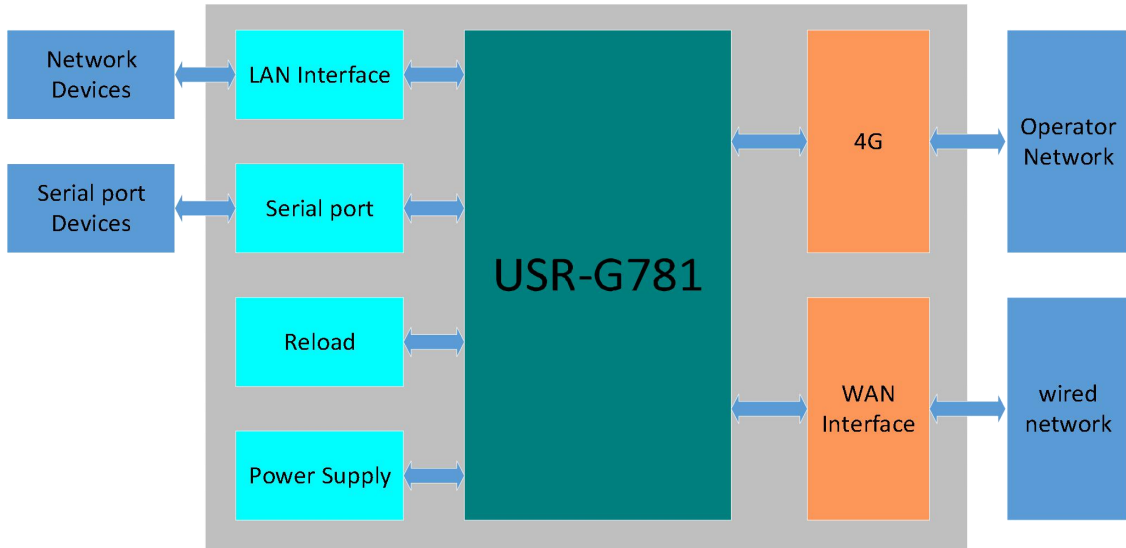

Figure 13 Router Functions diagram

2.2.1. Configuration procedure

Basic procedure as follows:

Step1: Keep G781 in power off condition.

Step2: Insert SIM card.

Step3: Connect antenna.

Step4: Power the G781.

Step5: Wait about one minute, NET LED light with purple, G781 can connect to 4G network.

Connection diagram as follow:

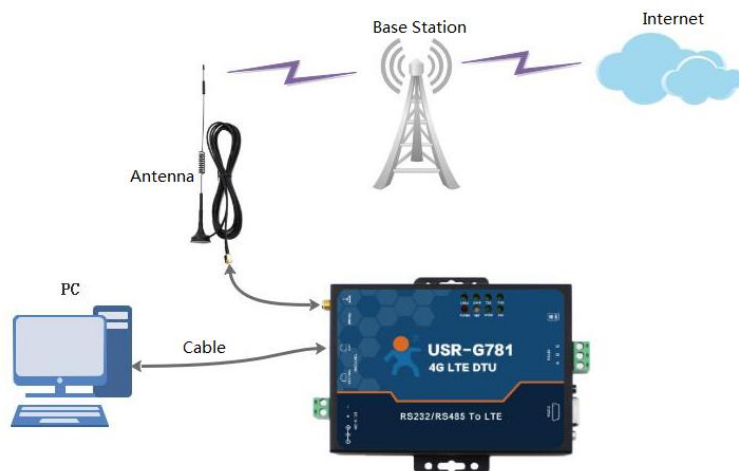

Figure 14 Application diagram

User can access network through G781. PC connect to G781 by LAN interface and PC should open DHCP function.

2.2.2. Networking mode

2.2.2.1. WAN+LAN+4G

Diagram as follows:

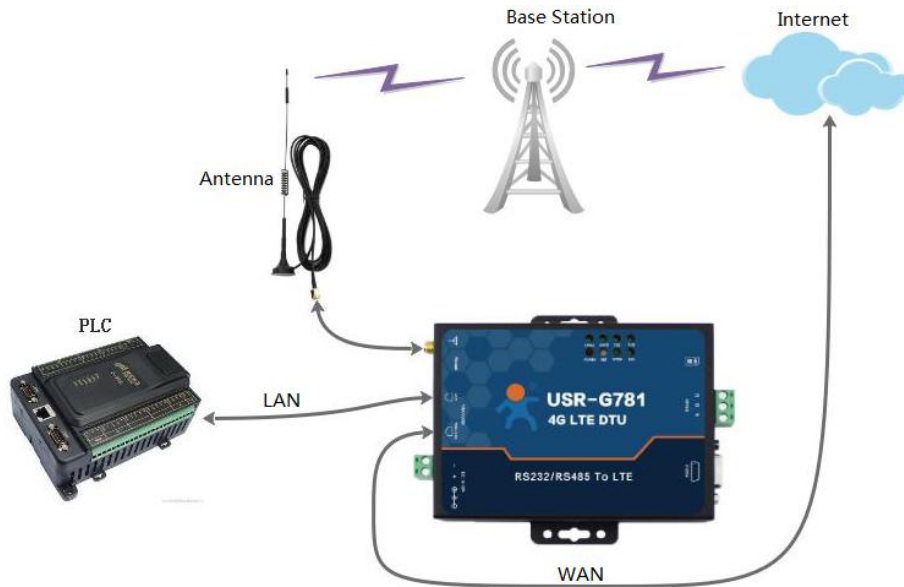

Figure 15 WAN+LAN+4G Application diagram

In this mode, users can connect to Internet through WAN or 4G. Default configuration is WAN has higher priority. When router can't connect Internet through WAN, it will change to 4G network.

2.2.2.2. LAN+LAN+4G

Diagram as follows:

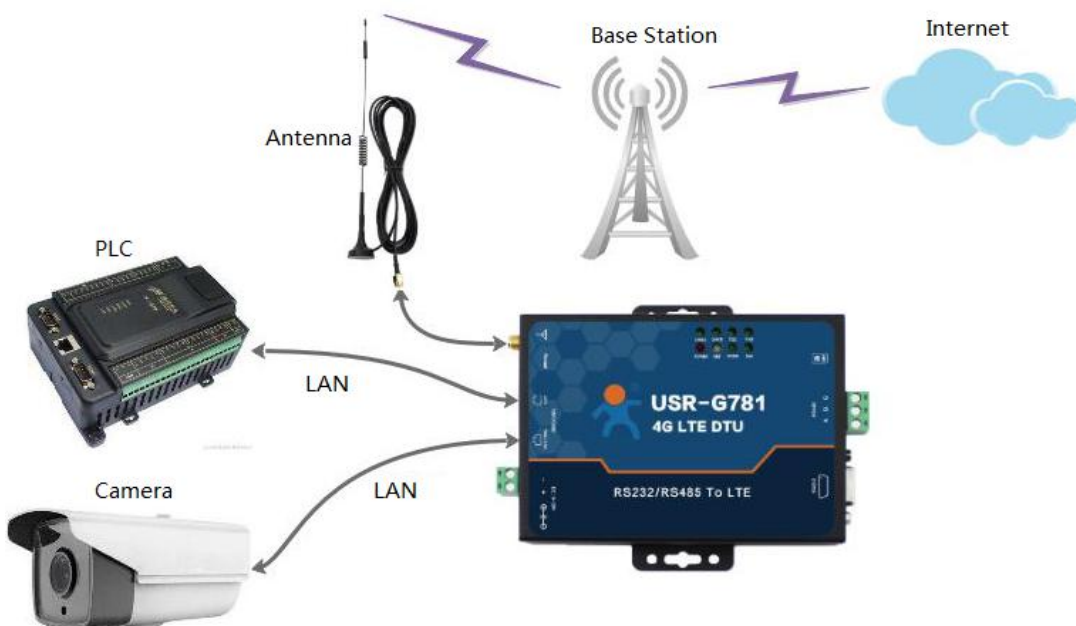

Figure 16 LAN+LAN+4G Application diagram

In this mode, two devices can connect to router through LAN and access the Internet by 4G network. To adopt

LAN+LAN+4G mode, user just need set WAN/LAN interface to LAN interface by Web Server as follow:

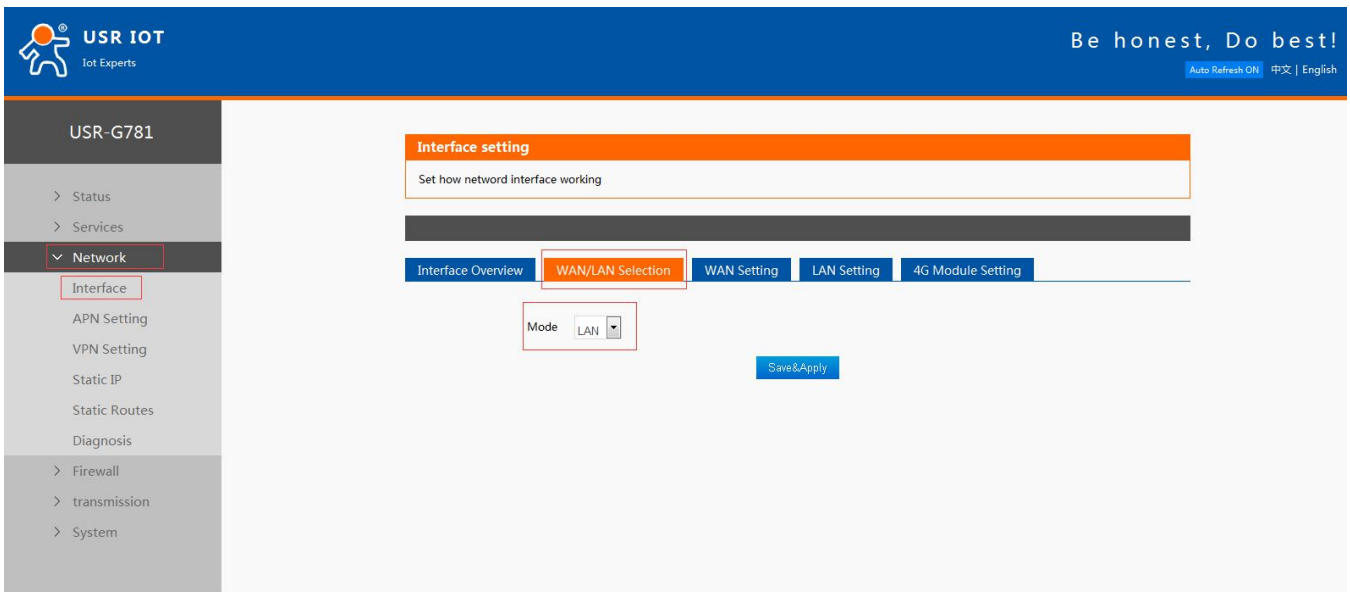

Figure 17 WAN/LAN interface switch

2.2.3. Features

2.2.3.1. 4G Interface

G781 support one 4G interface to connect Internet. Functional diagram as follows:

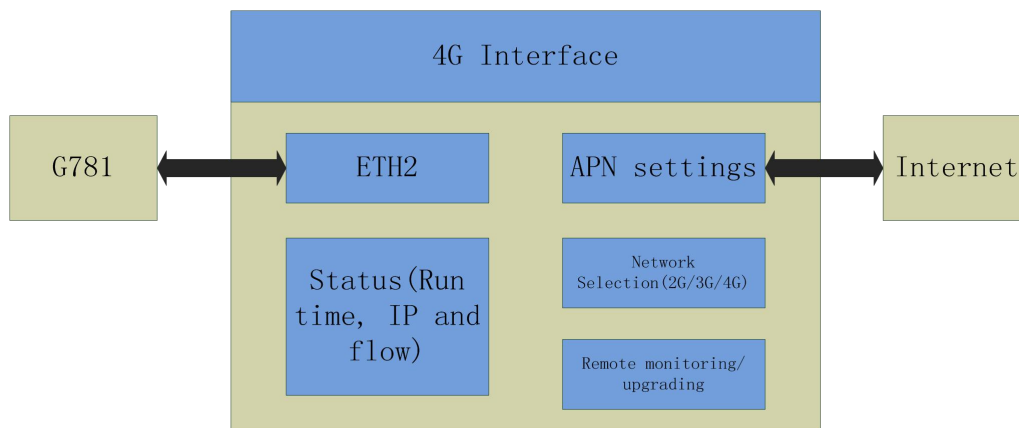

Figure 18 4G Interface

When user use 4G interface, the most important thing is to configure the APN parameters. User can refer to [2.1. APN](#) to configure the APN parameters.

2.2.3.2. LAN Interface

When user set WAN/LAN interface into LAN mode, G781 will have two LAN interface.

Default settings: Static IP address: 192.168.1.1; Subnet mask: 255.255.255.0; Open DHCP Server function.

User can configure LAN interface by Web Server as follow:

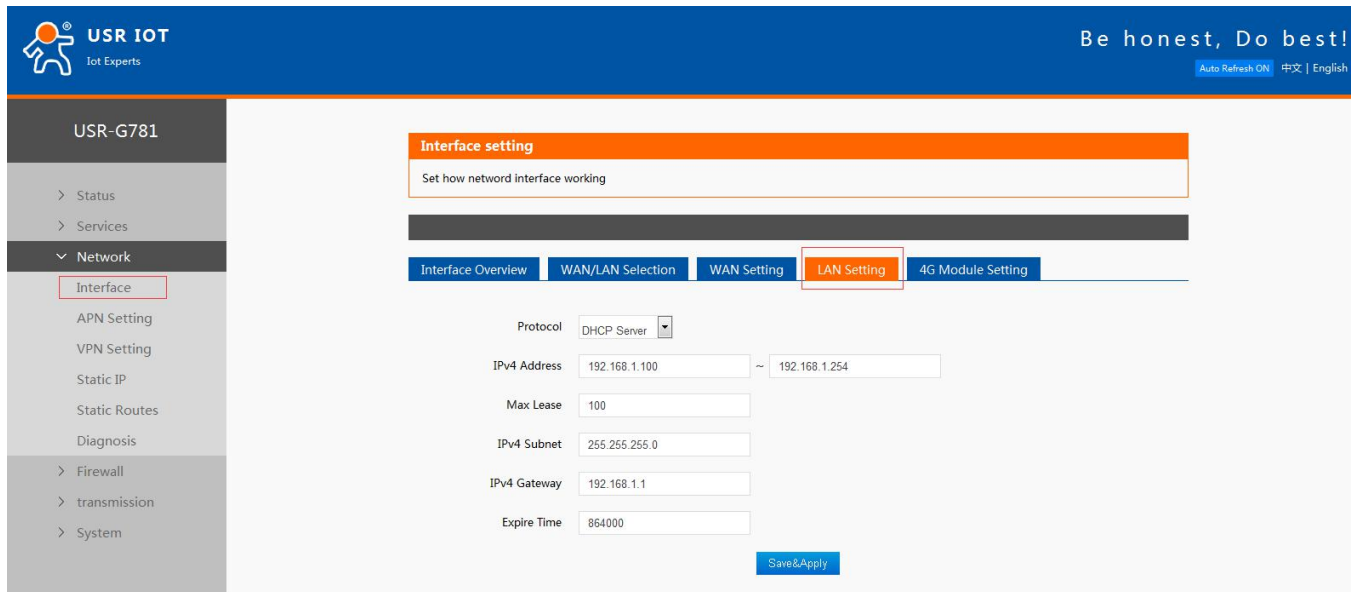

Figure 19 LAN interface configuration

2.2.3.3. WAN Interface

G781 has one WAN interface. Support DHCP Client and Static Address, default setting is DHCP Client.

User can configure WAN interface by Web Server as follow:

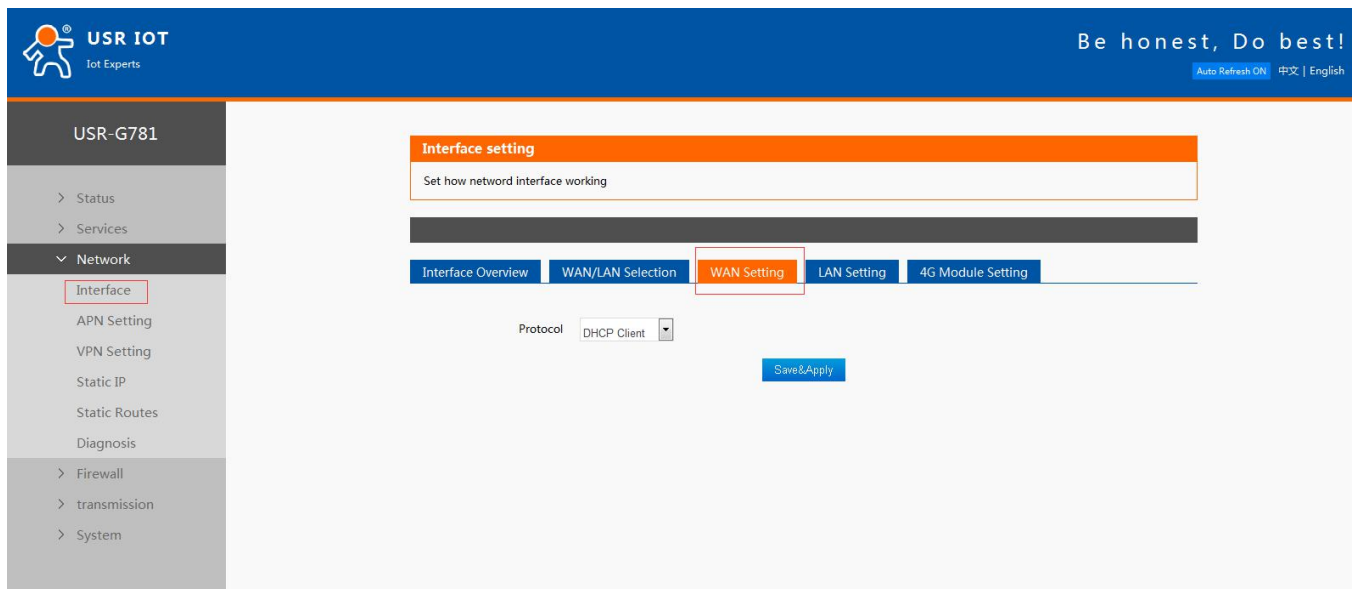

Figure 20 WAN interface configuration

2.2.3.4. DHCP Server function

DHCP default range of distribution from 192.168.1.100 to 192.168.1.254 and default address expire time is 86400 seconds (ten days). Address range and expire time can be changed.

User can configure DHCP Server function parameters by Web Server as follow:

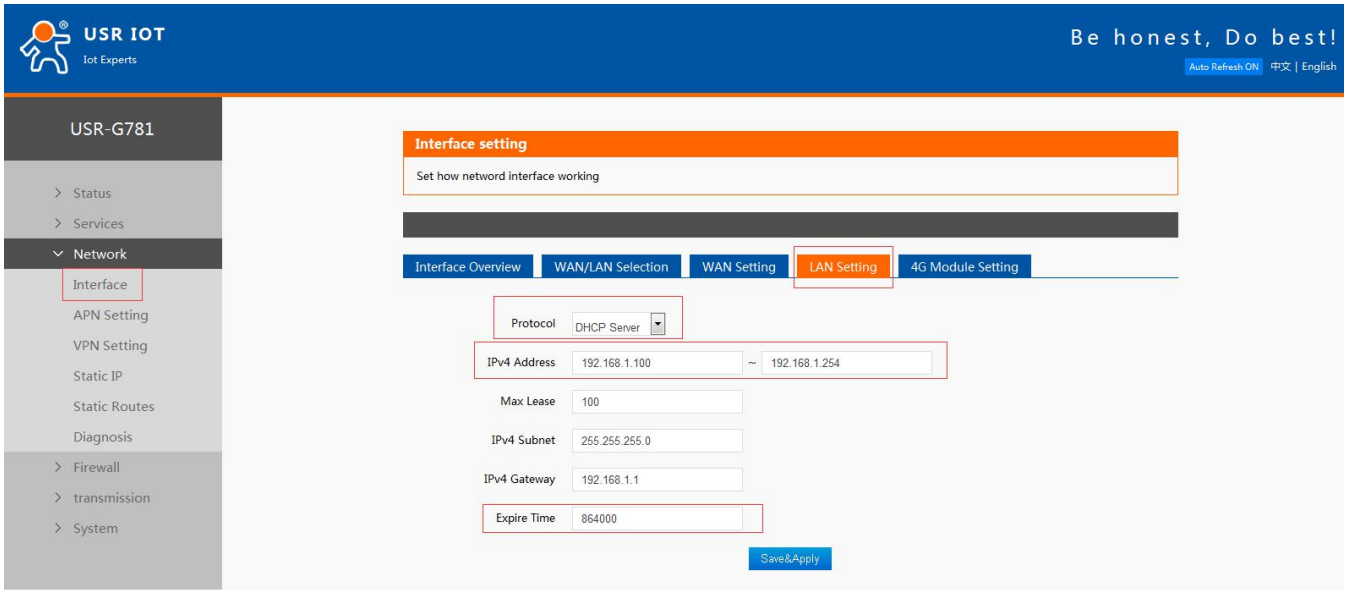

Figure 21 DHCP Server function configuration

2.2.3.5. VPN function

G781 only support PPTP mode to achieve VPN function now. And Subsequent versions will support L2TP, GRE, openvpn, ipsec mode.

User can configure VPN function by Web Server as follow:

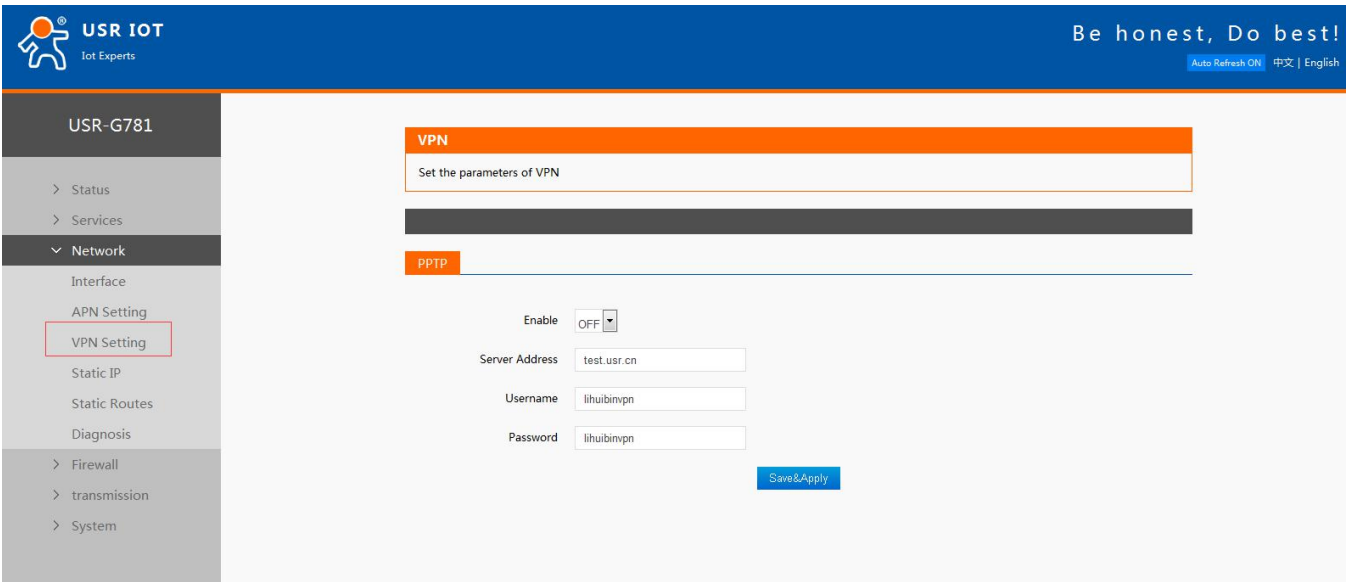

Figure 22 VPN function configuration

2.2.3.6. Static Routes function

User can set G781 Static Route table to achieve self-defined routing rules.

User can configure Static Routes by Web Server as follow:

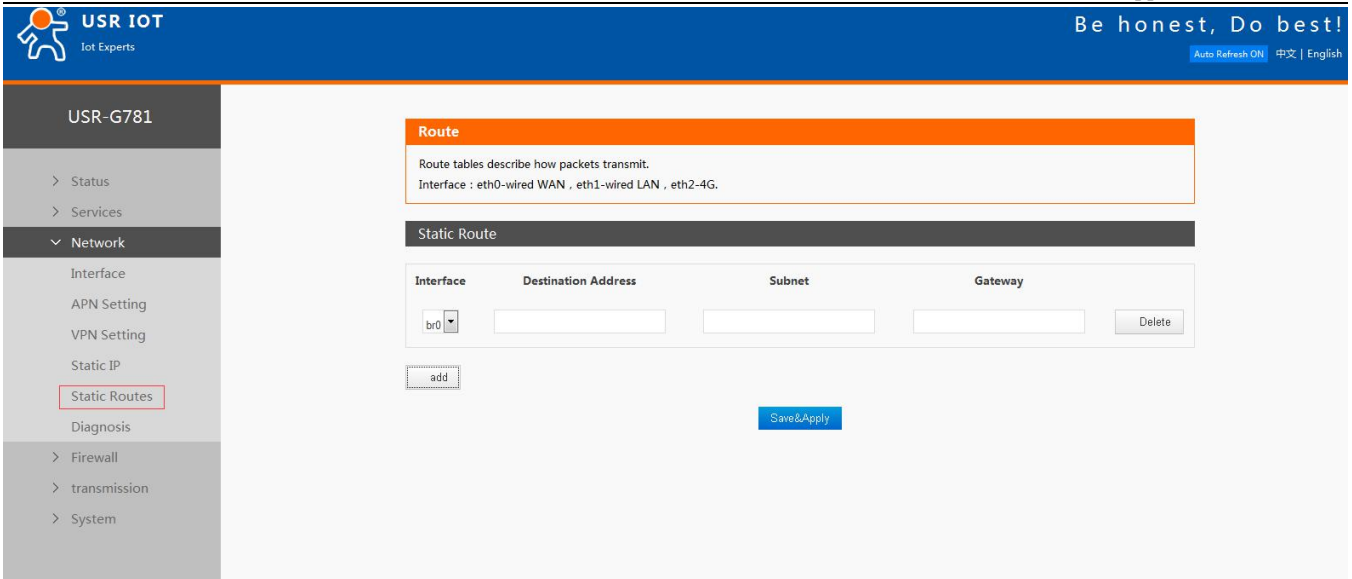

Figure 23 Static Routes function configuration

2.2.3.7. Static IP binding

User can bind IP address with MAC address and G781 will distribute fixed IP address to some devices.

User can bind IP and MAC by Web Server as follow:

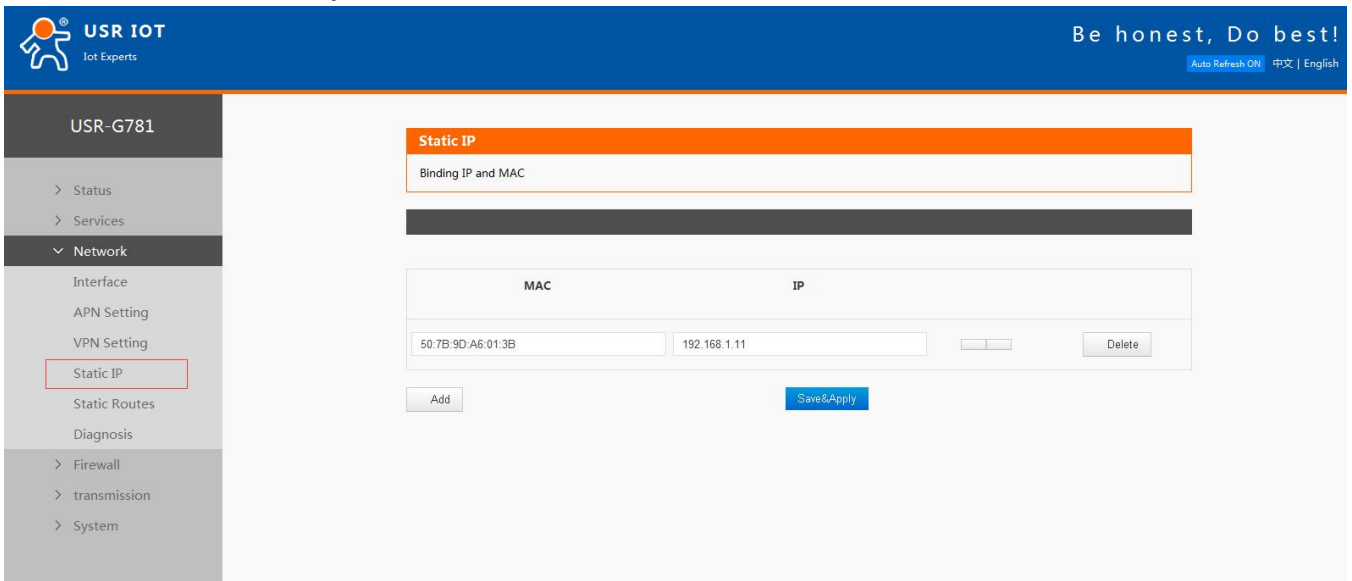

Figure 24 Static IP binding function configuration

2.2.3.8. Network diagnosis

User can use ping a specified address to check the connection status.

User can use Network diagnosis function by Web Server as follow:

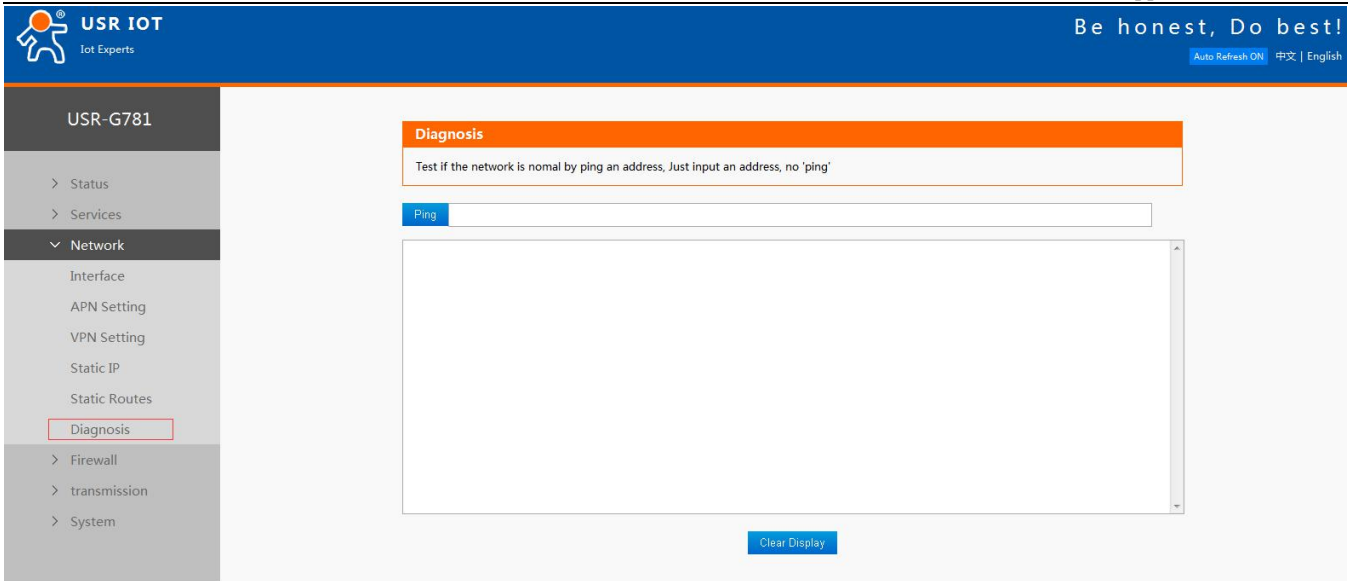

Figure 25 Network diagnosis

2.2.3.9. Firewall

By use Firewall function, user can set firewall Filter Table rules and Forward Table rules to manage Network security. And user can also add, delete and modify Firewall rules by sending iptables commands.

User can configure Firewall configuration by Web Server as follow:

Filter Table rules:

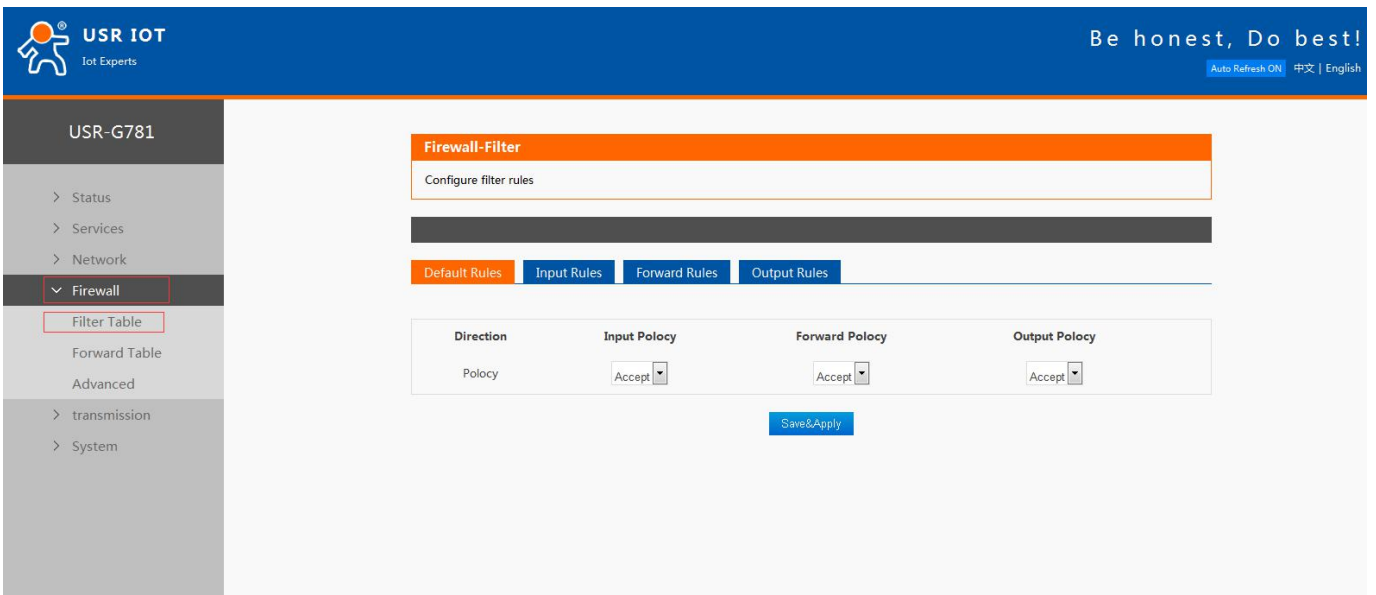

Figure 26 Filter Table rules configuration

Forward Table rules:

Firewall-Forward
Configure forward rules

Extranet->Intranet Intranet->Extranet

Action	Protocol	Destination Address	Destination Port	Mapping Address	Mapping Port	
DNAT	TCP	192.168.1.100/32	8800	21.45.30.15	8800	Delete
DNAT	TCP	192.168.1.101/32	8801	21.45.30.15	8800	Delete
DNAT	TCP	192.168.1.102/32	8802	21.45.30.15	8803	Delete
DNAT	TCP	192.168.1.103/32	8803	21.45.30.15	8804	Delete

Figure 27 Forward Table rules configuration

Sending iptables commands:

Firewall-Customized Command
Configure the rules of firewall by customized commands

iptables

Clear Display

Figure 28 Sending iptables commands

2.3. DTU Functions

This chapter introduces the DTU functions of USR-G781, as the following diagram shown, you can get an overall knowledge of it.

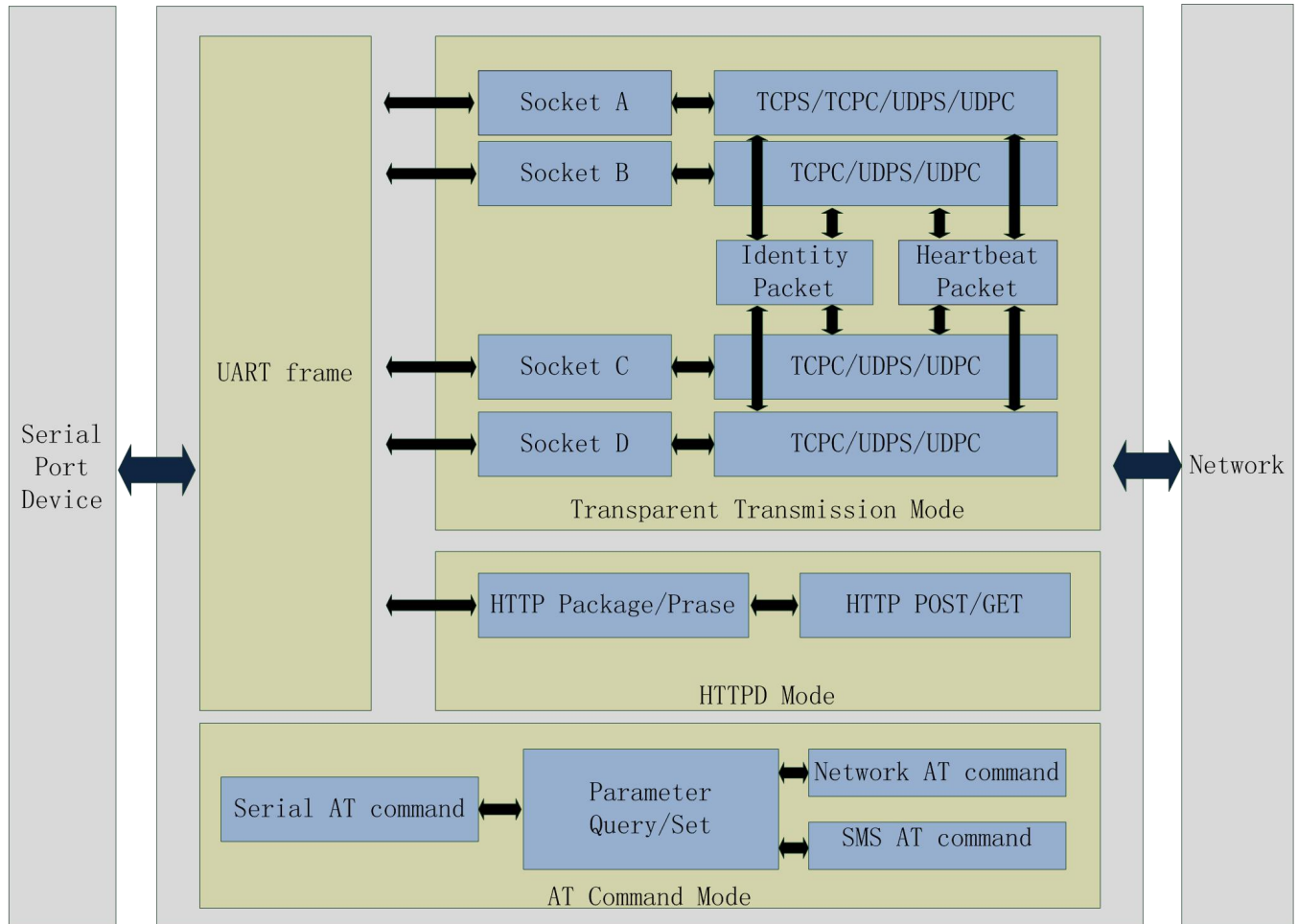

Figure 29 DTU functions diagram

2.3.1. Work Mode

2.3.1.1. Transparent Mode

Transparent Mode: What you sent to serial will be forward to network. The communication is bidirectional.

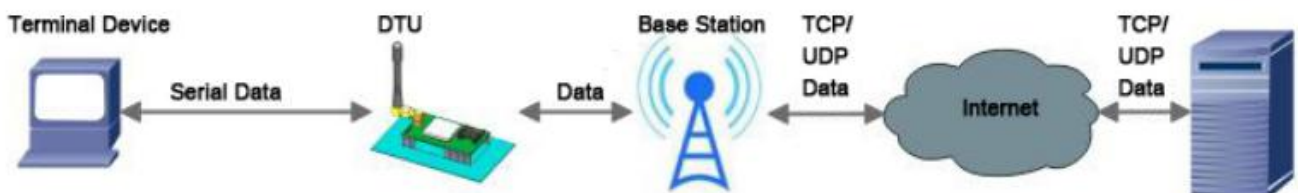

Figure 30 Transparent Mode

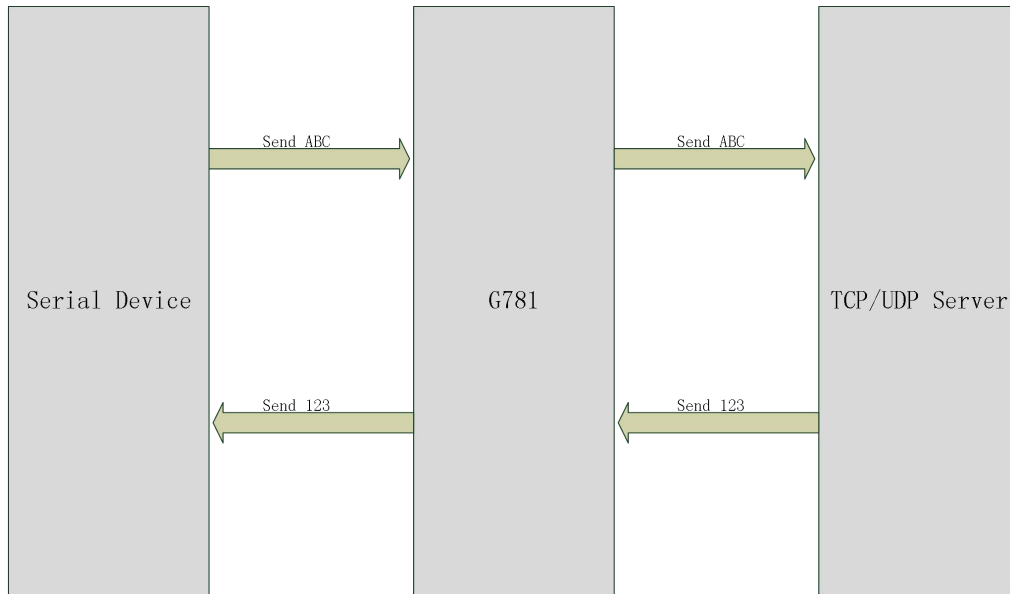

Figure 31 Transparent mode diagram

<Illustration>:

USR-G781 supports 4 socket connections simultaneously: socket A, socket B, socket C and socket D, they are independent. Socket A supports TCP Server, TCP Client, UDP Server and UDP Client. Socket B, socket C and socket D support TCP Client, UDP Server and UDP Client.

User can configure the Transparent Mode by setup software as follow:

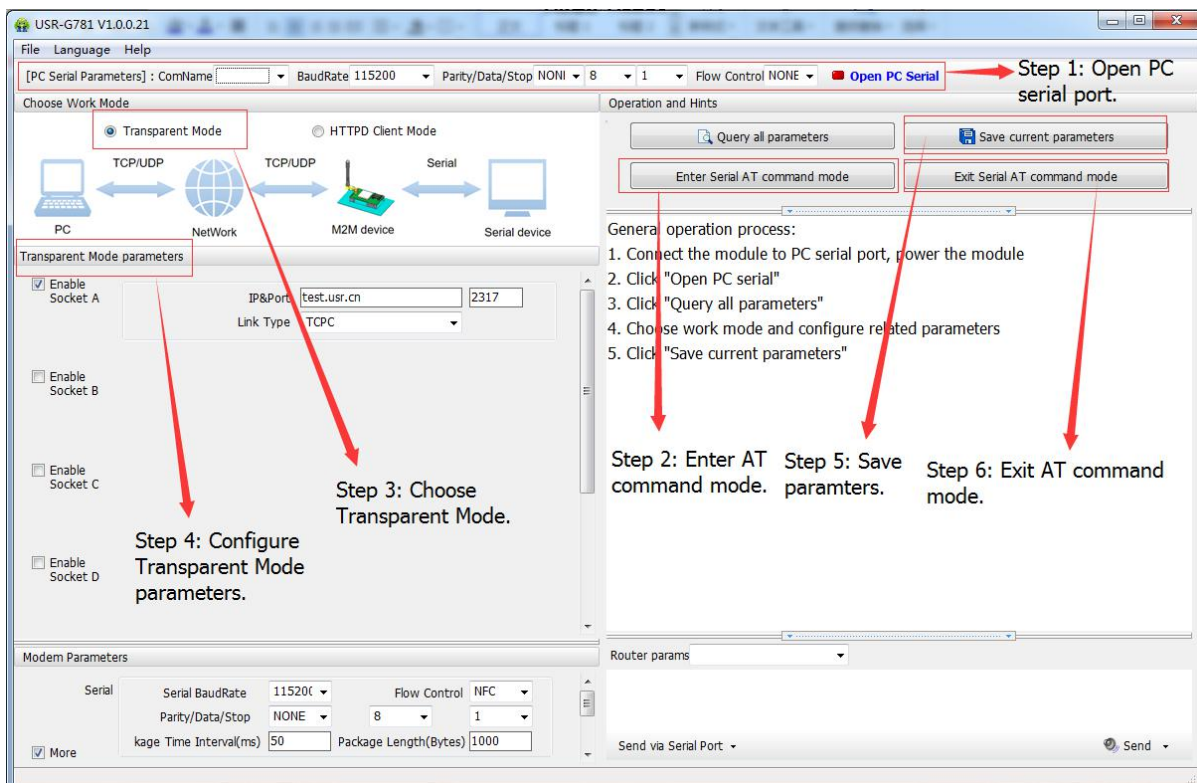

Figure 32 Transparent Mode configuration

2.3.1.2. HTTPD Client Mode

HTTPD Client Mode: DTU will add the HTTP Header for every data from serial and transfer HTTP format data to Network. User needs to configure the HTTP Header before use this mode. User can use this mode transfer the serial data to HTTP server.

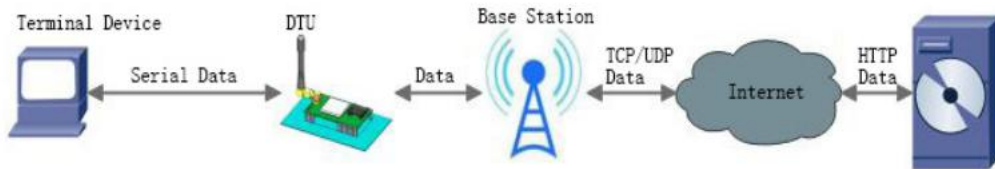

Figure 33 HTTPD Client Mode

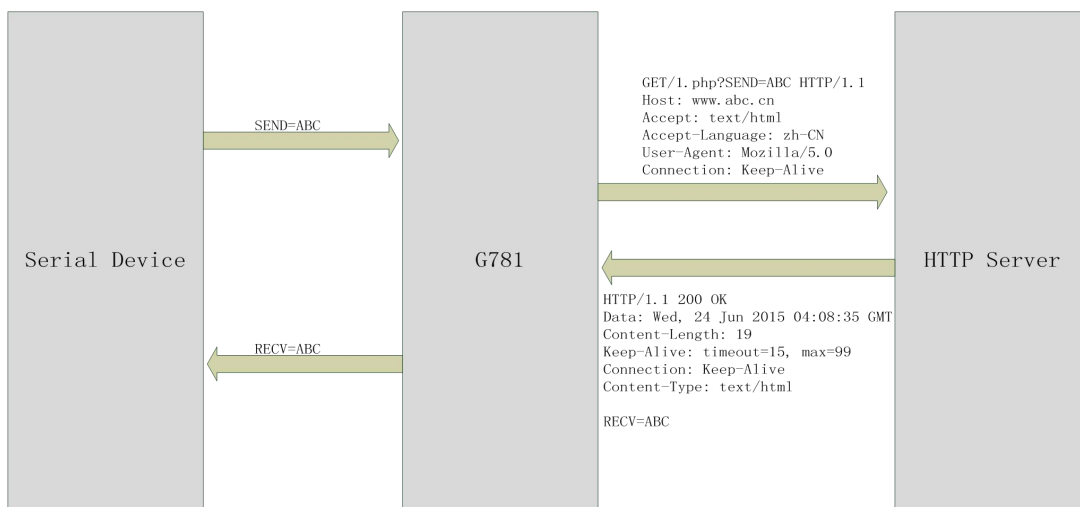

Figure 34 HTTPD Client Mode Diagram

User can configure HTTPD Client mode by setup software as follow:

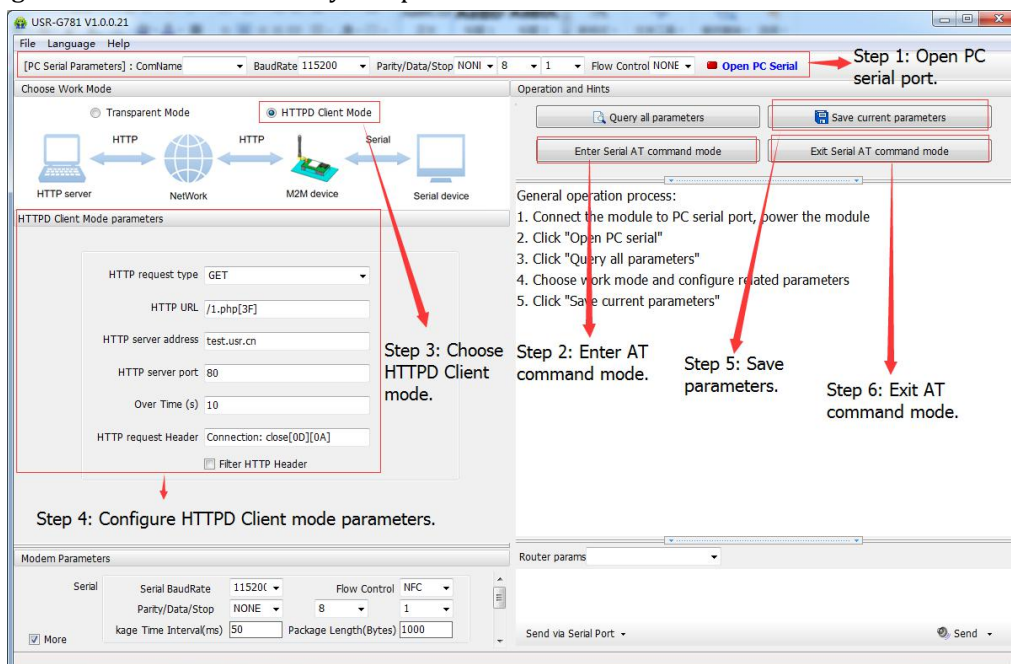

Figure 35 HTTPD Client mode configuration

2.3.2. Serial Port

2.3.2.1. Parameters range

Items	Parameters
Baud Rate	300, 600, 1200, 2400, 4800, 9600, 19200, 38400, 57600, 115200, 230400, 460800
Data Bits	7,8
Stop Bits	1,2
Parity	NONE EVEN ODD
Flow Control/485	NFC: None Flow Control 485:When you use RS485, please choose this function

Figure36 Serial parameters

2.3.2.2. Serial Package Methods

For network speed is faster than serial. Module will put serial data in buffer before sending it to network. The data will be sent to Network as Package. There are 2 ways to end the package and send package to network - Time and Length.

2.3.2.2.1. Time Trigger Mode

If no data get from serial over the time threshold, it will end the package and send this package to network. The range of threshold is from 10ms ~ 60000ms. Default is 50ms. If the serial keeping send data, this package will be 1K bytes.

2.3.2.2.2. Length Trigger Mode

The package will be sent to network when it up to length threshold. The range of length threshold is from 1 to 4096 bytes. Default is 1000 bytes.

2.3.2.3. Baud Rate Synchronization

When module works with USR devices or software, serial parameter will change dynamically according to network protocol. Customer can modify serial parameter by sending data conformed to specific protocol via network. It is temporary, when restart DTU, the parameters back to original parameters.

2.3.3. Features

2.3.3.1. Identity packet Function

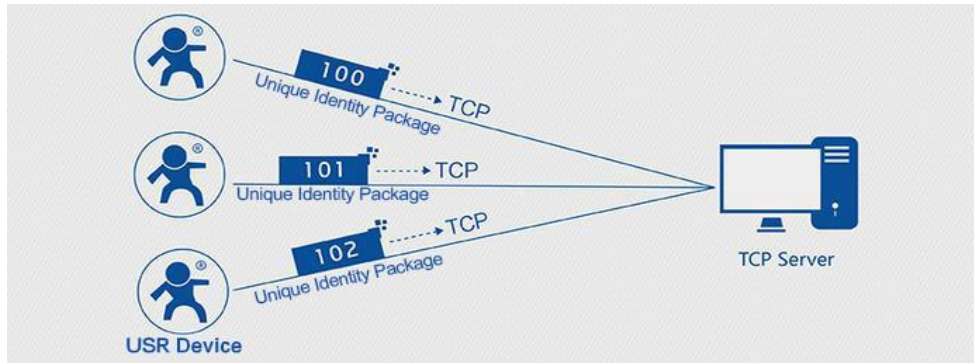

Figure 37 Identity packet

Identity packet is used for identify the device when module works as TCP client/UDP client. There are two sending methods for identity packet.

- Identity packet will be sent when connection is established. (Only for TCP client)
- Identity packet will be added on the front of every data package. (TCP client and UDP client)

Type of identity packet: ICCID, IMEI, USR Cloud and USER.

- ICCID, the unique identifier of SIM card, suitable to the application based on SIM card identification.
- IMEI, the unique identifier of DTU, suitable to the application based on device identification.
- USR Cloud, the identification code based on USR Cloud platform. For more information about USR Cloud, please go to cloud.usr.cn/en/.
- USER, user can use own editable identity packet data.

User can configure identity packet function by setup software as follow:

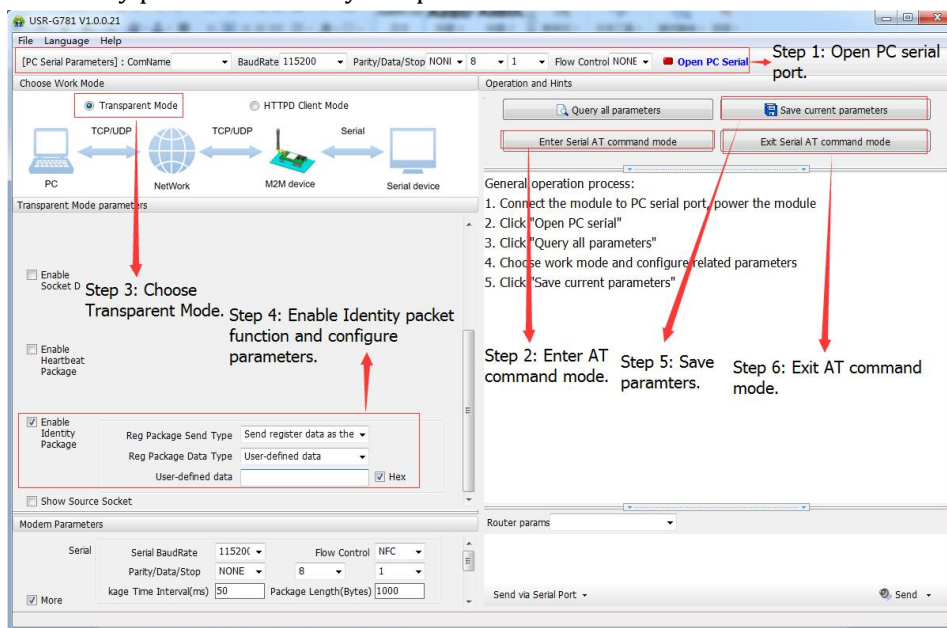

Figure 38 Identity packet function configuration

2.3.3.2. Heartbeat packet Function

Heartbeat packet: Module will output heartbeat packet data to serial or network periodically. User can configure the heartbeat packet data and time interval. Serial heartbeat packet can be used for polling Modbus data. Network heartbeat packet can be used for showing connection status and keep the connection.

Heartbeat packet is only available in transparent mode. User can configure heartbeat packet function by setup software as follow:

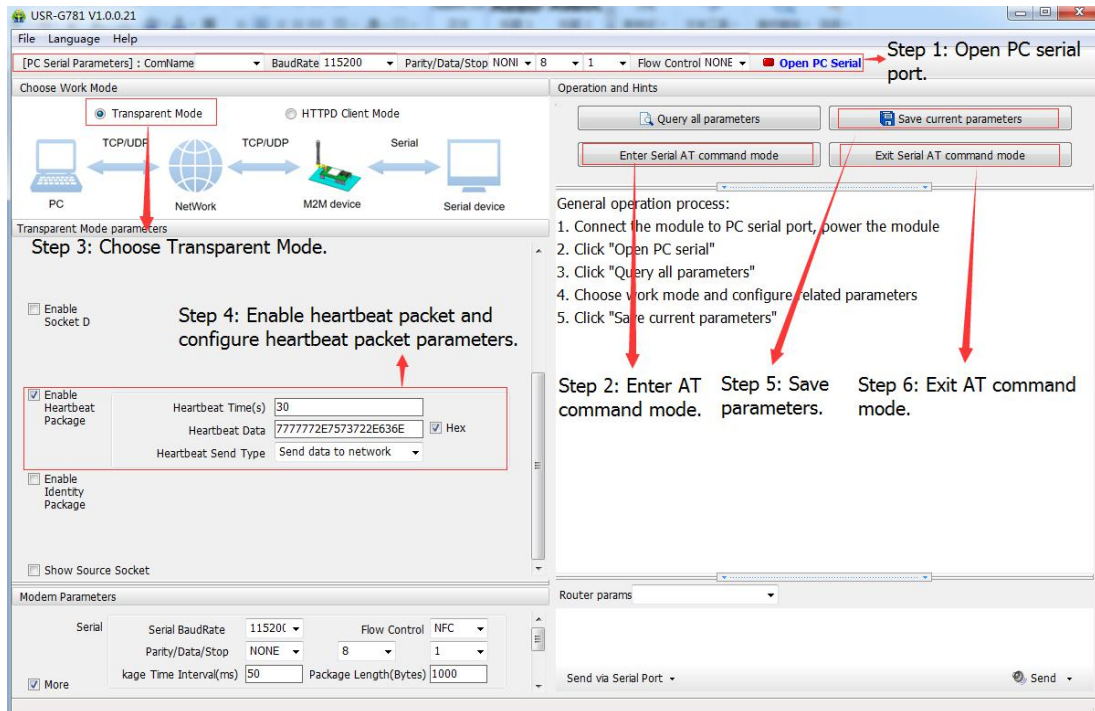

Figure 39 Heartbeat packet function configuration

2.4. Basic functions

2.4.1. Reload by Hardware

User default settings: User can save the settings as User default settings.

Press Reload button for 3~15 seconds and release, USR-G781 will restore user default settings.

3. Parameter Setting

There are two ways to configure USR-G781. They are Web Server configuration and AT command. Web Server configuration mainly configure router functions and AT commands mainly configure DTU functions. We also provide the setup software based on serial AT command. You can download the setup software in our website <http://www.usriot.com/usr-g781-setup-software-v1-0-0-0/>.

3.1. Web Server Configuration

User can connect PC to G781 through LAN interface and set PC as DHCP. Then enter Web Server to configure.

Web Server default parameters as follows:

Parameter	Default settings
Web Server IP address	192.168.1.1
User name	Admin
Password	Admin

Figure 40 Web Server default parameters

After connecting PC to G781, user can open browser and enter 192.168.1.1 into address bar, then log in user name and password, user will enter into Web Server. Web Server screenshot as follow:

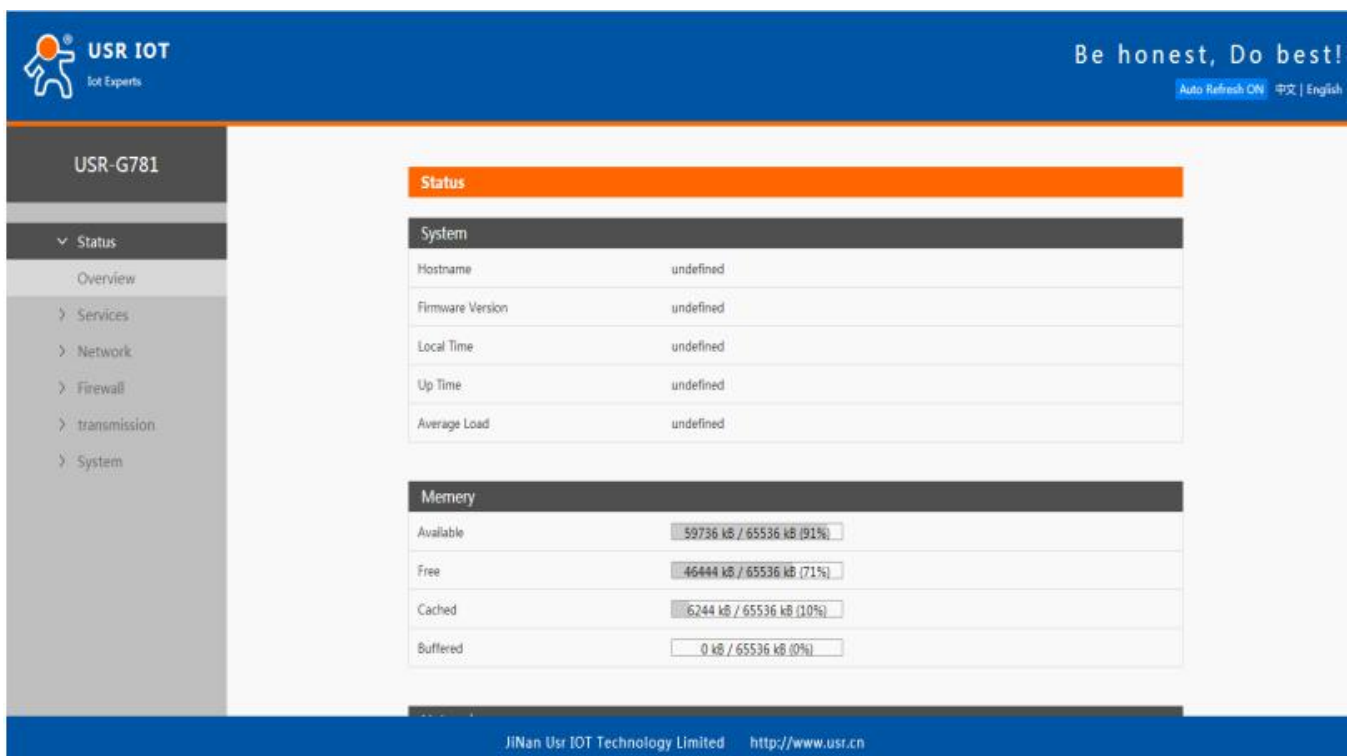

Figure 41 Web Server configuration

3.2. AT Command

3.2.1. Serial AT Command

In transparent mode, SMS mode and HTTPD mode, you can enter AT command mode. Then you can send AT command to module. Setup software is based on this function. For entering AT command mode, please refer to this FAQ: <http://www.usriot.com/enter-serial-command-mode/>.

3.2.2. Setup software

We also provide the setup software based on serial AT command. You can download the setup software in our website <http://www.usriot.com/usr-g781-setup-software-v1-0-0-0/>. Software screenshot as follow:

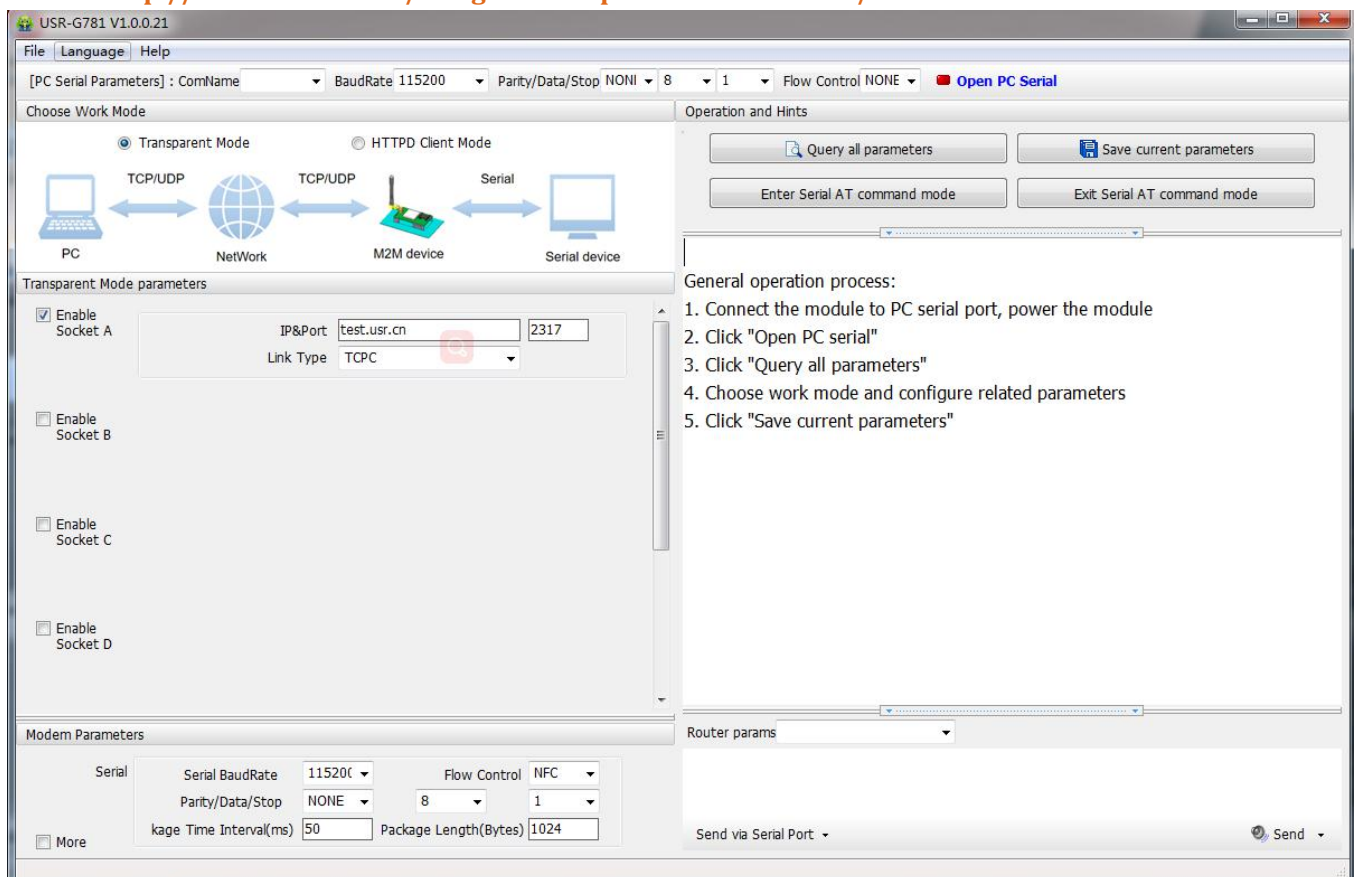

Figure 42 Setup software

3.2.3. Transparent AT Command

When module in transparent mode, you can use “Password+AT command” format to send AT command via serial or network. If you use transparent AT command, you needn’t enter AT command mode.

Default command password is **www.usr.cn#** and user can send AT command AT+CMDDPW to change password. Take querying firmware version with default password as an example, user need send **www.usr.cn#AT+VER[0D]** ([0D] represents carriage return and user must end the whole command with carriage return. It’s same as serial AT command.).

4. Contact Us

Company: Jinan USR IOT Technology Limited

Address: Floor 11, Building 1, No. 1166 Xinluo Street, Gaoxin District, Jinan, Shandong, 250101, China

Web: www.usriot.com

Support: h.usriot.com

Email: sales@usr.cn

Tel: 86-531-88826739/86-531-55507297

5. Disclaimer

This document provide the information of USR-G781 products, it hasn't been granted any intellectual property license by forbidding speak or other ways either explicitly or implicitly. Except the duty declared in sales terms and conditions, we don't take any other responsibilities. We don't warrant the products sales and use explicitly or implicitly, including particular purpose merchant ability and marketability, the tort liability of any other patent right, copyright, intellectual property right. We may modify specification and description at any time without prior notice.

6. Update History

2017-07-25 V1.0.06.01 established.

2017-10-13 V1.0.06.02 updated. Adding descriptions including words and figures about how to configure G781's different functions. Modifying some specific words to standard terms. Formatting whole manual arrangement.